

140 - 310

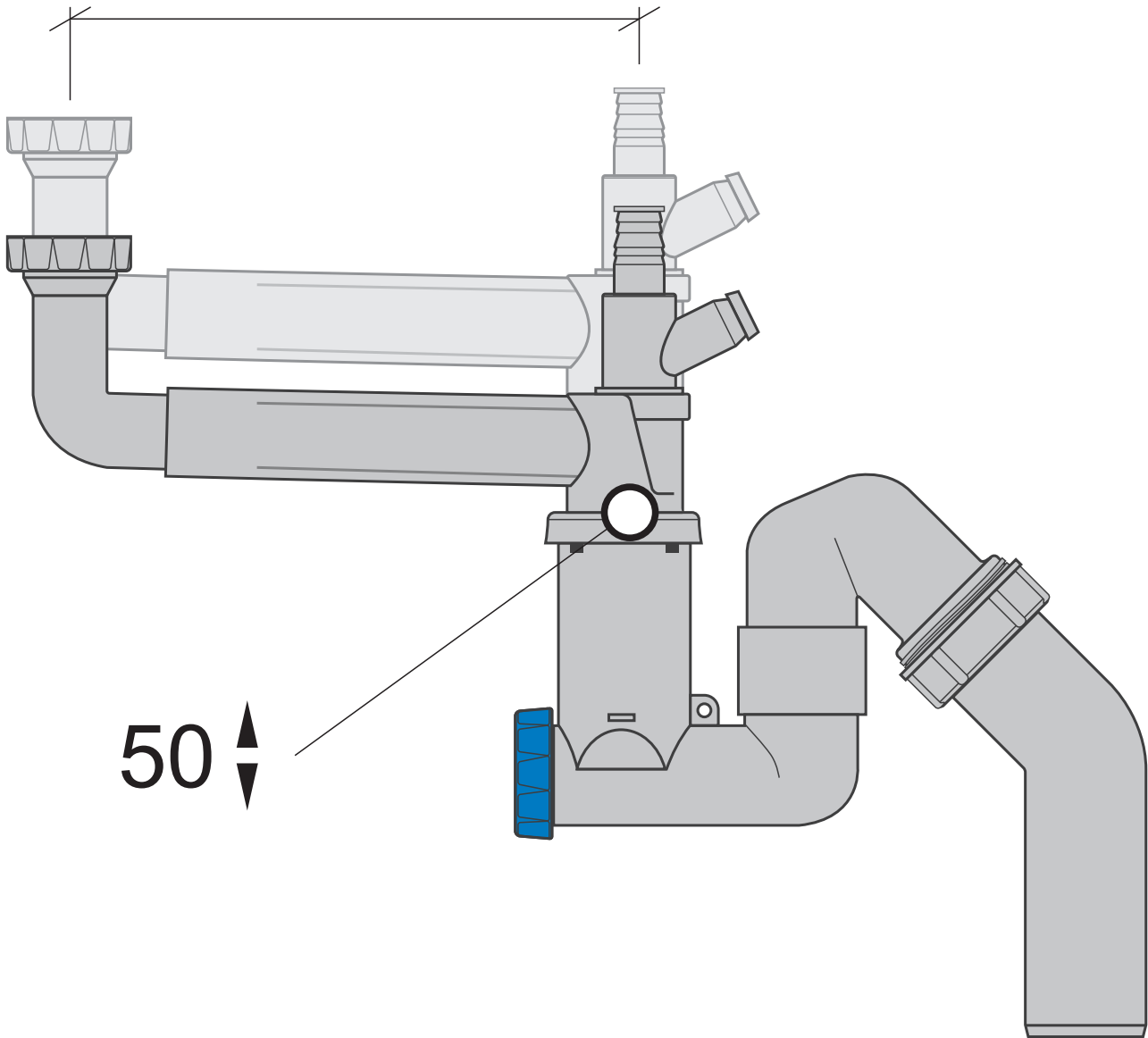

50